

# Installation instructions

## *Lucernario Ventilation-light shaft finish*

*Standard version*



## Table of contents

### Contents

Table of contents .....	2
Foreword .....	3
Safety .....	3
Guarantee .....	3
Disclaimer .....	3
Installation instructions .....	3
Supporting structure.....	4
Slope .....	5
Preparation .....	6
Installation .....	7
Technical support during installation.....	8

## Foreword

### Safety

- Always observe the safety instructions for the materials and tools to be used.
- Always wear the appropriate personal protective equipment (gloves, safety goggles etc.).
- We would suggest that any roof works is completed by an experienced roofer.
- Always have any electrical works carried out by a certified electrician.
- Please note that the installation works is carried out at your own risk.

### Guarantee

- The product has a 7-year manufacturer's warranty for any manufacturing defects.
- Please retain the original proof of purchase to validate the product warranty.
- Any costs associated to the installation of any replacement parts covered under the warranty remain at the expense of the purchaser.
- Our terms and conditions are available upon request.

### Disclaimer

Techcomlight Limited expressly disclaims any liability for any unexpected additional expense arising as a result of condensation or any water damage resulting from condensation, installation not in accordance with Techcomlight Limited's installation guide/s or any other external influences beyond the control of Techcomlight Limited. Techcomlight Limited cannot be held liable for damage to structures caused as a result of making openings and installing the product supplied. Techcomlight assumes no responsibility or obligation for the failure of an architect, contractor, installer or building owner to comply with all applicable laws, ordinances, building codes, energy codes, fire and safety codes and requirements, and adequate safety measures.

Installation instructions reserved. No rights can be derived from this publication.

# Supporting structure

Lucernario against façade

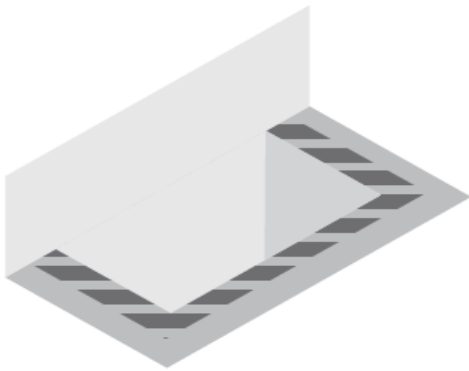

Detached Lucernario

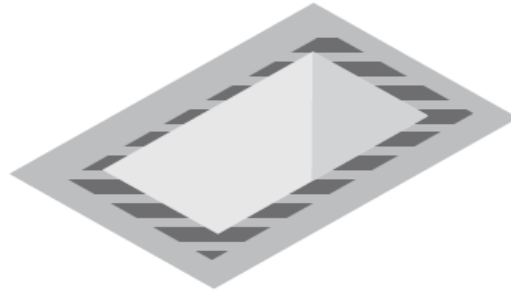

Support structure for Lucernario



The load-bearing capacity of the Lucernario Ventilation light shaft finish has been calculated and tested with a load-bearing surface on 3 sides (figs. 1 and 2), but it is also possible to install the Lucernario in a light-shaft with a load-bearing surface on 2 opposite sides (figs. 3 and 4).

## Support:

**YES**

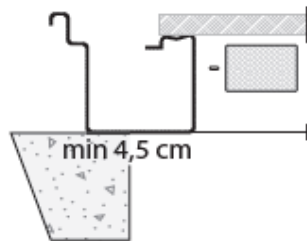

**NO**

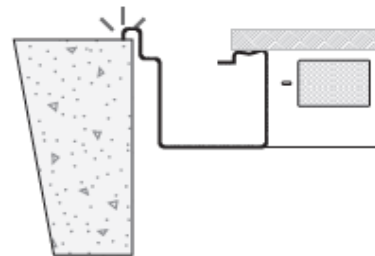

The Lucernario must rest with the underside of the gutters on a load-bearing reinforced concrete construction of at least 4.5 cm wide.

## Slope

Minimum slope: 1%

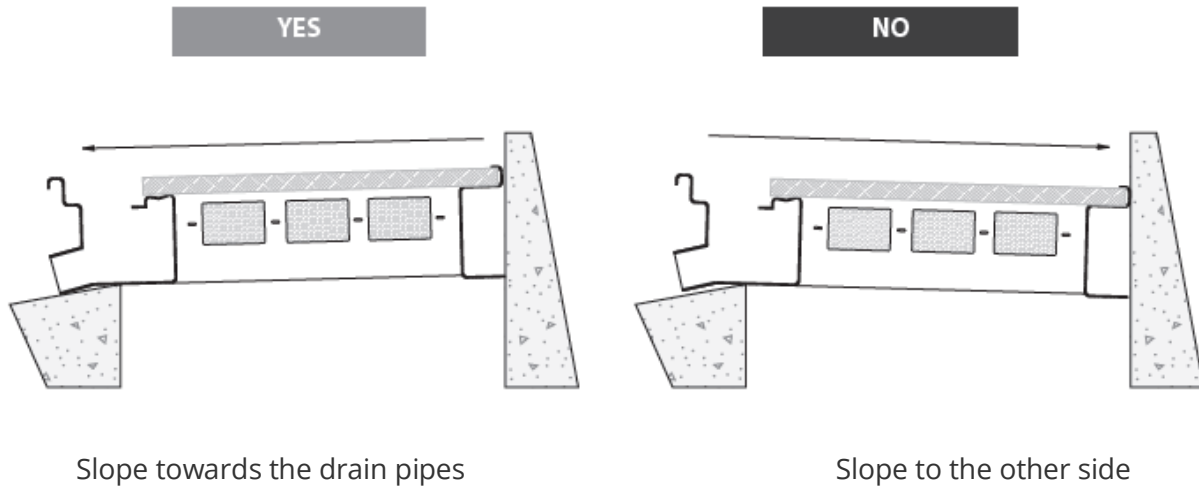

### WARNING

The Lucernario should not be used as a water drainage point for large amounts of water. It is advisable to connect the drain pipes to an independent water drain with large capacity, so that not too much water gets into the gutters of the Lucernario. If this is not taken into account, there is a risk of water entering the light shaft via the ventilation grilles of the Lucernario.

## Preparation

Before the start of the work:

Remove the loose grates from the Lucernario and store them in a dry, clean place

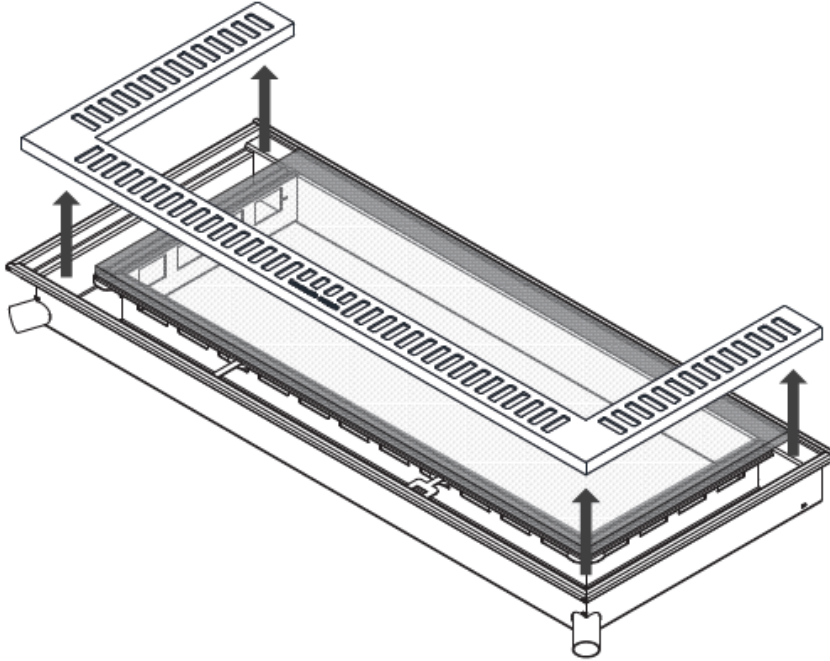

Protect the glass surface with sturdy cardboard or bubble wrap

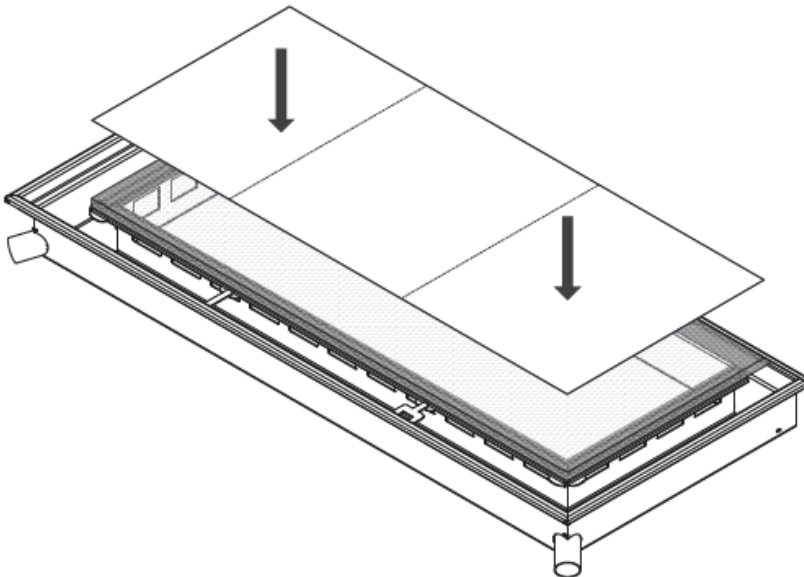

The images may differ from the product in question

## Installation

1. Place the Lucernario on top of the light shaft, take into account the weight of the Lucernario when moving or lifting, this is indicated on the label or the supplied technical information.
2. Place the Lucernario so that the drain pipes are facing to the lowest point of the floor (page 4: minimum slope). The drainage pipes themselves do not ensure water drainage, only the mounting of the Lucernario on the right slope ensures good water drainage.
3. In the event that there are only 2 or 3 concrete edges on which the Lucernario rests, apply a metal corner strip of 50x50 mm and at least 2 mm thick on the side(s) where there is no support, exactly between (and at the height of the) top edge of the concrete edges. Before screwing it on, a good layer of Liquid Rubber Joint filler must be applied to the back, so that no water can run behind it. Make sure that the corner strip is grease-free and sanded and that the wall is dust-free.
4. Clean the concrete edges well to ensure they are dust free. Also clean the underside of the gutters of the Lucernario thoroughly: first degrease with a degreaser, then lightly sand, degrease again and finally let them dry well.
5. Use spacers or, for example, 2 mm thick rubber tape to keep some space between the Lucernario and the concrete edge. Check the stability of this support and whether the slope is still correct.
6. Apply 3 full beads of at least 10 mm thickness of Joint filler from Liquid Rubber lengthwise on top of the concrete edge and on the corner strip, so that a waterproof layer is created all around.
7. Now place the Lucernario on the concrete edge and corner strip, so that it beds down onto the Liquid Rubber Joint filler. Check that the Lucernario is still stable and at the correct slope.
8. Waterproof the seams on the back between the Lucernario and the wall with Liquid Rubber Joint filler.
9. Then take the paste HBS200 from Liquid Rubber and apply it generously with a brush over the seam between the concrete edge and the Lucernario. This is important so take your time!
10. If desired, a layer of AB Sealant from Liquid Rubber can be applied inside for additional water protection. This is a white paste for the inside of the light shaft that can be painted over, but can also be plastered or wallpapered.
11. Connect 2 PVC pipes Ø 50 mm waterproof to the drain pipes of the Lucernario.

12. Wait at least 24 hours for the Liquid Rubber to dry, then check that it has hardened properly and only then proceed to finish the floor around the Lucernario. If in doubt, an extra layer of HBS200 paste can always be applied over it.

13. Remove the protection from the glass and replace the grids only after all work has been completed.

## Technical support during installation

If you need help installing your Lucernario, please contact us:

Dutch: [info@techcomlight.nl](mailto:info@techcomlight.nl) or 0318-693820  
Flemish: [info@techcomlight.be](mailto:info@techcomlight.be) or 0318-693820  
English: [info@techcomlight.co.uk](mailto:info@techcomlight.co.uk) or 02475 097713

*Thank you for purchasing this Lucernario product.*

*The product Lucernario aerante® INOX and the brand Lucernario are the property of Bottega del Ferro. Bottega del ferro is the manufacturer and Techcomlight is the distributor for the Benelux, the United Kingdom and Ireland. Bottega del Ferro reserves the right to change the properties and characteristics of the products shown without prior notice.*

*This document and all other documents relating to Lucernario products can be found at:*

Dutch: <https://lucernario.nl/>  
Flemish: <https://lucernario.be/>  
French: <https://lucernario.fr/>  
English: <https://lucernario.co.uk/>



Bottega del ferro  
Via del Boscone, 8  
25014 Castenedolo (BS) Italia  
T. +39 030 2731985  
F. +39 030 2130930  
[info@bottegadelferro.net](mailto:info@bottegadelferro.net)  
[www.bottegadelferro.net](http://www.bottegadelferro.net)  
[inox.lucernarioaerante.it](http://inox.lucernarioaerante.it)



**Techcomlight is the distributor of Lucernario**  
[Shop.techcomlight.co.uk](http://Shop.techcomlight.co.uk)